



SPOA3T-5
Series 700
2 Column Surface-mounted Lift
 Series SPOA3T Capacity:
 3500 kg



**O
P
E
R
A
T
I
N
G

I
N
S
T
R
U
C
T
I
O
N
S**

Contents 2
Safety Instructions 3
Lift Operation 4
Operating Instructions 7
Inspection and Maintenance Instructions for the Operator 8
Troubleshooting for the Operator 9
Repair, Maintenance, and Inspection for Authorized Maintenance Personnel... 10
Troubleshooting for Authorized Maintenance Personnel 12
Adjustment of the Synchronization Wire Ropes 13
Instructions for Manual Lowering 13

INSTALLER: Please return this manual to the documentation and hand it to the lift owner/operator.

LP20324

OM20174

Rev. F 10/2014

EG-Konformitätserklärung EC Declaration of Conformity

im Sinne der EG-Richtlinie 2006/42/EG über Maschinen (Anhang II A)
according to EC directive 2006/42/EC on machinery (Annex II A)

Name und Anschrift des Herstellers
Name and address of the manufacturer:

Rotary Lift
2700 Lanier Drive
Madison, IN, 47250 USA

**Name und Anschrift seines in der EU
niedergelassenen Bevollmächtigten**
his authorised representative in EU

BlitzRotary GmbH
Hüfinger Str.55
78199 Bräunlingen, Germany

Diese Erklärung bezieht sich nur auf die Maschine in dem Zustand, in dem sie in Verkehr gebracht wurde; vom Endnutzer nachträglich angebrachte Teile und/oder nachträglich vorgenommene Eingriffe bleiben unberücksichtigt. Die Erklärung verliert ihre Gültigkeit, wenn das Produkt ohne Zustimmung umgebaut oder verändert wird.

This declaration relates exclusively to the machinery in the state in which it was placed on the market, and excludes components which are added and/or operations carried out subsequently by the final user. The declaration is no more valid, if the product is modified without agreement.

Hiermit erklären wir, dass die nachstehend beschriebene Maschine
Herewith we declare, that the machinery described below

Produktbezeichnung / product denomination:

Serien- / Typenbezeichnung / model / type:

**2-Säulen-Hebebühne / 2-post vehicle lift
SPOA3T**

Tragfähigkeit 3500 kg / capacity 3500 kg

Maschinen-/Seriennummer / machinery / serial number:

.....

Baujahr / Year of manufacture:

20...

allen einschlägigen Bestimmungen der Maschinenrichtlinie 2006/42/EG entspricht.

Die Maschine entspricht zusätzlich den Bestimmungen der Richtlinien 2004/108/EG über elektromagnetische Verträglichkeit und 2006/95/EG über elektrische Betriebsmittel (*Schutzziele wurden gemäß Anhang I, Nr. 1.5.1 der Maschinenrichtlinie 2006/42/EG eingehalten*).

is complying with all essential requirements of the Machinery Directive 2006/42/EC.

In addition the partly completed machinery is in conformity with the EC Directives 2004/108/EC relating to electromagnetic compatibility and 2006/95/EC relating to electrical equipment (Protection objectives have been met in accordance with Annex I No. 1.5.1 of the Machinery Directive 2006/42/EC).

Angewandte harmonisierte Normen / Harmonised Standards used

EN 1493: 2010	Fahrzeug-Hebebühnen / Vehicle lifts
EN ISO 12100:2010	Sicherheit von Maschinen - Grundbegriffe / Safety of Machinery- Basic concepts
EN 60204-1:2006+A1:2009	Elektrische Ausrüstung von Maschinen / Electrical equipment of machines
EN 349:1993+A1:2008	Sicherheit von Maschinen-Mindestabstände / Safety of machinery - Minimum gaps
EN ISO 13850:2008	Sicherheit von Maschinen-Not-Halt / Safety of machinery - Emergency stop

Angewandte sonstige technische Normen und Spezifikationen

Other technical standards and specifications used:

BGG 945	Prüfung von Hebebühnen / inspection of vehicle lifts
BGR 500	Betreiben von Arbeitsmitteln / management of working appliances
BGV A3	Unfallverhütungsvorschrift elektrische Anlagen und Betriebsmittel / law accident prevention regulation of electric facilities and equipment

Bevollmächtigter für die Zusammenstellung der relevanten technischen Unterlagen:

The person authorised to compile the relevant technical documentation:

Herr Pohl; Hüfinger Str. 55; 78199 Bräunlingen

Ort / Place : Bräunlingen

Datum / Date : 19.03.2013



Frank Scherer
Geschäftsführer / Managing Director

Only technicians trained for use and servicing of the lift should operate the lift.

It is possible that local regulations specify that trained operators must have reached a minimum age of 18 years or must be supervised by a trained operator when they:

- A. position a vehicle in the work area**
- B. position the lift adapters at the lifting points recommended by the vehicle manufacturer**
- C. operate the lift controls**

Please display the manual so that it is clearly visible in the vicinity of the lift.

This lift may be used ONLY for vehicles without occupants!

ALWAYS lift the vehicle with all four (4) adapters!

NEVER lift only one end, one corner, or one side of the vehicle.

In compliance with the permissible load capacity, the load distribution of the front to the rear lifting points must not exceed the ratio of 3:2 or 2:3.

MODEL	LOAD CAPACITY
Lift Series SPOA3T-5	3500 kg (7720 lbs.)

Lift Operation

TS/ TC-VERSION:

M-VERSION:

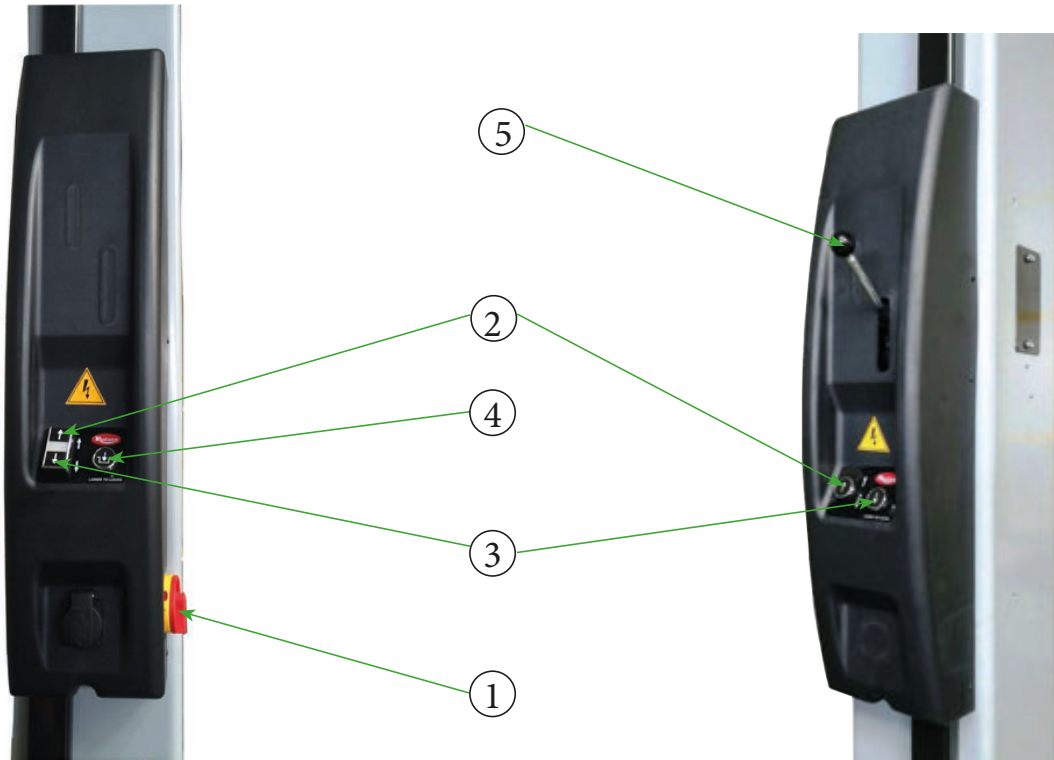

Fig. 1

1	E-stop switch - <i>(In the OFF position, a lock can be installed to prevent unauthorized lift operation.)</i>
2	Lift raising
3	Lift lowering
4	Lowering the lift to the detent
5	mechanical unlocking

OPERATING INSTRUCTIONS

Surface-mounted body lift

⚠ CAUTION

In order to avoid injuries to persons and/or damage to property, the lift should be operated only by trained personnel. After reading these instructions, run several times through the operation sequences to familiarize yourself with operation of the lift and before you load a vehicle onto the lift.

IMPORTANT

ALWAYS lift the vehicle with all four (4) adapters! **NEVER** lift only one end, one corner, or one side of the vehicle.

For vehicles with a truck body: Make sure that the vehicle frame holds the vehicle weight and that the overhead beam comes into contact with the highest point of the vehicle.

1. Before Loading:

- Check the lift for correct operational readiness.
- Make sure that the lift has been lowered completely and that the work area is free from any interfering objects, grease and oil, and that there are no other persons in the area.
- Swivel the arms with grease-free and oil-free adapters to the pass-through position.
- Turn the E-stop switch to the "ON" position.
- Persons, who are not authorized should NOT remain within the work area while the lift is in operation.
- Do NOT use the lift as a crane or a support for other hoisting mechanisms (e.g. block and tackle).

2. Loading:

- Persons who are not authorized or not trained should NOT load the vehicle and should NOT operate the lift.
- Do NOT drive over the arms.
- Do NOT overload the lift. Observe the load capacity sign on the lift.
- ONLY use adapter extensions provided by the lift manufacturer. Do NOT use wood or concrete blocks or other improvised extensions.
- Position the vehicle over the lift, with the left front wheel in the correct wheel receiver plate position (see Fig. 3). (Position the vehicle according to the center of gravity, not in a way which makes the door opening accessible).
- Check the condition of the mounting points on the vehicle.
- Swivel the arms under the vehicle and position the adapters at the mounting points recommended by the vehicle manufacturer (Fig. 4). Bring the adapters to the respective height in order to hold the vehicle level and maintain safe contact with the adapters.
- Use optional adapters for the recesses under the body, if required.
- The min. distance between the front and rear mounting points is 0.7 m (see Fig. 2).

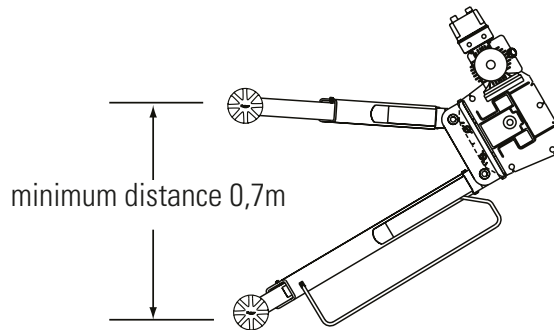



Fig. 2

3. Lift raising:

- NOBODY should be on the lift or in the vehicle while the lift is moving.
- Stay away from the lift during the lifting process, but keep the arms, the mounting points, and the vehicle in sight.
- Operate the  switch. Stop before contact with the vehicle. Check the arm guidance pins for latching. If required, move the arm slightly, so that the retaining ring and the pawl can latch. Do NOT use a hammer on the pin, as this could damage the teeth of the retaining ring.

Note: Wait (2) seconds until start of the motor. Failure to do so can cause the motor to burn.

- Raise the vehicle until the tires no longer have contact with the floor.
- Shake the vehicle at the front or the rear bumper to check the stability.
- Stop: Check the adapter for safe contact with the mounting points recommended by the manufacturer of the vehicle.
- Raise vehicle to the desired height only when stability is assured.

- Operate the  switch (Fig. 1) to lower the lift onto the pawls when the desired height has been reached.
- Do NOT walk under the vehicle, unless all four adapters are in secure contact with the mounting points recommended by the vehicle manufacturer.
- Repeat placing, loading, and raising, if the vehicle is not stable.





4. Whilst Using the Lift:

- Avoid extreme shocks to the vehicle while it is on the lift.
- Always use safety stands as required when heavy components are removed or installed. (Engines, transmission, etc.). (4) Use safety stands.
- Raise the safety stands so that they reach the vehicle, i.e. not lowering the vehicle onto the stands.
- Avoid touching of the exhaust system of a raised vehicle. Pay attention to air hoses and cables that may cause stumbling.
- Wear protective goggles under the vehicle.
- Nobody should climb onto the vehicle or the arms while the vehicle is being raised.

5. Before Lowering the Lift:

- Remove all tools and other objects from the lift area.
- Make sure that there are no persons in the lift area.

6. Lift lowering:

- Remain away from the lift and operate the  switch to raise the lift from the pawls.
- **M-VERSION:** Operate the  switch and the operation lever to raise the pawls.
- Operate the  switch to lower the lift. Keep your feet outside the lowering area!
- **M-VERSION:** Operate the operation lever and lower the lift via the  switch.

7. Unloading:

- Make sure that the lift has been lowered completely.
- Remove the adapters from under the vehicle and swivel the arms out to the full pass-through position, before the vehicle is moved out of the lift area.
- Make sure that the work area is free of interfering objects and that no other persons are in the area.

8. Power Off:

- Turn the E-stop switch to the "OFF" position when the lift is not to be used any more.

9. Troubleshooting:

- See page 8.

10. Maintenance:

- See page 7.ee

Typical Mounting Points

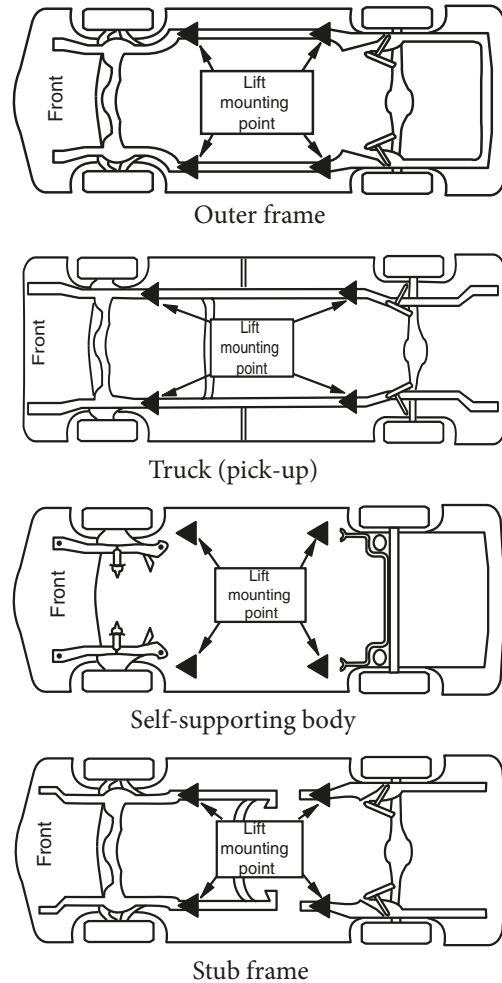

! CAUTION

Most special vehicles or modified vehicles cannot be raised on a body lift. Contact the vehicle manufacturer for information concerning raising of the vehicle.

Fig. 3

Residual Risks

- Check the condition of the mounting points on the vehicle. Make sure that these points are not weakened by rust, corrosion, damage, or modification.
- Vehicles with heavy loads in the trunk or vehicles modified for the transport of loads have a different center of gravity. Use stands when working on such vehicles.
- Make sure that the load doesn't exceed the permissible load spreading.

INSPECTION AND MAINTENANCE INSTRUCTIONS FOR THE OPERATOR

(MAINTENANCE AUTHORIZED BY THE OPERATOR)

- Bolts/Screws always should be tightened securely. Check regularly.
- Always make sure that the arm stop bolts are in position.
- Always keep the lift components clean.
- If an oil leak is observed, always notify local service personnel.
- Daily: Check wire ropes and sheaves for wear. If parts are worn, notify local service personnel.
- Daily: Inspect the adapters for damage or strong wear. If parts are worn, notify local service personnel.
- Daily: Check the pawl for function and forming. If they are deformation, notify local service personnel.
- Monthly: Check the tension of the synchronization wire ropes. If parts are worn, notify local service personnel.
- Monthly: Check that the switch of is functioning.
- Monthly: Clean and check the base of the lift. Remove rust and repair with paint.
- Every 3 months: Check that the bolts are seated securely in the anchoring. Anchoring should be tightened with the torque specified by the manufacturer.
- Every 6 months: Check the oil level of the hydraulic aggregate and fill up to the correct level (level indication with fully lowered lift).
- Replace all signs on the lift which are no longer legible or missing. Stickers (signs) can be ordered from Rotary Lift.

TROUBLE-SHOOTING FOR THE OPERATOR

Up switch  is pressed, but the lift is not raised.

Problem	Cause	Countermeasure
 switch is pressed, but nothing happens.	1. Operation is not functioning.	1. Contact service personnel if you need help.
Motor is not running (both columns).	1. Wrong power supply to the power supply unit.	1. Contact service staff if you need help.
Motor runs, but the lift is not raised.	1. Lift overloaded.	1. Check the vehicle weight and/or the balance of the vehicle on the lift. 2. Contact service personnel if you need help.

Down switch  is pressed, but the lift is not lowered.

Problem	Cause	Countermeasure
 switch is pressed, but nothing happens.	1. Operation is not functioning. 1	1. Contact service personnel if you need help.
The pawls do not latch.	1. Pawl spring (latch spring) defective.	1. Contact service personnel if you need help.

Down switch  is pressed, but the lift is not lowered.

Problem	Cause	Countermeasure
 switch is pressed, but nothing happens.	1. Operation is not functioning.	1. Contact service personnel if you need help.

M-VERSION: Operation lever is pressed, but the lift is not lowered.

Problem	Cause	Countermeasure
Operation lever pressed, but nothing happens. Operating lever for unlocking and activated button or lowering pressed down, but nothing happens.	1. Operation wire rope torn. 2. Press button or lowering valve defect.	1. Contact service personnel if you need help. 2. Contact service personnel if you need help.

REPAIR MAINTENANCE

(MAINTENANCE AUTHORIZED BY QUALIFIED SERVICE PERSONNEL)

- Switch off all energy sources before a repair is started.
- Do NOT modify the lift in any way without prior written agreement of the manufacturer.
- In case of problems in the electric system, perform repair according to the local regulations. Use only original repair spare parts when a part has to be replaced.
- Replace worn parts (when required) only by original Rotary parts.
- Adjust the tension of the synchronization wire ropes according to the lift installation instructions.
- Monthly: Lubricate the axis of the pawls. Move the pawl handle (lath handle) or pawls manually several times, so that the oil gets into the joints.

YEARLY INSPECTION (EXECUTED BY AUTHORIZED PERSONNEL)

In addition to the routine inspections under "Maintenance Instructions for the Operator", the following yearly inspections must be performed at the site and a record of the inspection must be drawn up. All defects must be eliminated by appropriately authorized personnel.

INSPECTION ITEMS

- Check the accessibility of all operation processes.
- Check the accessibility and legibility of all stickers.
- Check the rated load capacity of the lift.
- Check all load-carrying components, including welding seams.
- Check cables for damage to the insulation.
- Check the oil level.
- Check the functioning of the lift operation.
- Check for correct function of the arm guides.
- Check that all fastening parts including the anchor bolts are seated securely.
- Check exposed surfaces and edges.
- Operate the lift and check the mechanical stop and the pawls of the lift.
- Check correct function of the adapters.
- Check the lowering speed of the lift loaded with a vehicle (should not exceed 0.15 m/sec).
- Check the function of the synchronization or compensation system (are both sides raised or lowered equally?).
- *Check for correct function of the overhead switch.
- Inspect all accessible lines, hoses, pipes, valves, and holders. Check the oil consumption of the lift.
- *Guide the lift through complete operation processes and observe.
- Stop the loaded lift midway through the raising process and check for lowering and hydraulic leaks.
- Ask the operator for unusual operation characteristics.

**Inspect with and without a vehicle on the lift.*

TROUBLE-SHOOTING FOR AUTHORIZED MAINTENANCE PERSONNEL

Problem	Cause	Repair
Motor is not running.	<ol style="list-style-type: none"> 1. Wrong power supply to the motor. 2. Cable connections defective/loose. 3. Motor UP switch burnt out. 4. Overhead cutoff burnt out. 5. Motor windings burnt out. 	<ol style="list-style-type: none"> 1. Correct power supply to the motor. 2. Repair and insulate all connections. 3. Replace the main switch/operation. 4. Replace the overhead cutoff. 5. Replace the motor.
Motor runs, but the lift is not raised.	<ol style="list-style-type: none"> 1. Lift overloaded. 2. Motor does not receive sufficient current. 3. Deposits in the lowering valve. 4. Pump sucks air. 5. Suction nozzle not on the pump. 6. Low oil level. 7. Safety valve not adjusted correctly. 	<ol style="list-style-type: none"> 1. Check the vehicle weight and/or the balance of the vehicle on the lift. 2. Correct power supply to the motor. 3. Clean the lowering valve. 4. Tighten the mounts of the suction lines. 5. Replace the suction nozzle. 6. Fill the tank up to the correct oil level with hydraulic oil ISOVG32 or Dexron III ATF. 7. Replace the safety valve cartridge.
The lift slowly lowers.	<ol style="list-style-type: none"> 1. Deposits in the check valve set. 2. Deposits in the lowering valve set. 3. External oil leakage. 	<ol style="list-style-type: none"> 1. Clean the check valve. 2. Clean the lowering valve. 3. Repair external oil leakage.
Low raising speed or oil from the filler vent lid.	<ol style="list-style-type: none"> 1. Air in the oil. 2. Air in the oil inlet. 3. Loose oil return hose. 	<ol style="list-style-type: none"> 1. Change the oil, use Dexron III ATF or SOVG32. 2. Tighten the mounts of the suction lines. 3. Newly install the oil return hose.
The lift does not rise uniformly.	<ol style="list-style-type: none"> 1. Synchronization wire ropes not adjusted. 2. Lift not installed on level ground. 	<ol style="list-style-type: none"> 1. Adjust the synchronization wire ropes to correct the tension. 2. Equalize the lift so that the columns are at the same height (linings not to exceed 13 mm). When exceeding 13 mm, chisel the floor and equalize according to the installation instructions.
Anchoring does not remain secure.	<ol style="list-style-type: none"> 1. Holes drilled too large. 2. Thickness and strength of the concrete floor not sufficient. 	<ol style="list-style-type: none"> 1. Shift the lift and drill new holes at a new location. The corresponding anchoring methods and the minimum installation conditions are described in the installation instructions. 2. Break out the old concrete and pour a new backing for the lift.
The lift does not rise all the way or rattles.	<ol style="list-style-type: none"> 1. Low oil level. 2. Air in hydraulic lines or hydraulic cylinders. 	<ol style="list-style-type: none"> 1. Fill the tank up to the correct oil level with hydraulic oil ISOVG32 or Dexron III ATF. 2. Start the system and raise the lift by 610 mm. Open the cylinder bleeder by approximately 2 turns. Close the bleeder when oil flows out. Lower the lift and fill the tank.
The pawl magnets become extremely hot when the lift is lowered.	<ol style="list-style-type: none"> 1. No cause. 	<ol style="list-style-type: none"> 1. No countermeasure, this is normal.
<p>Note: A shim thickness of 51 mm is possible with the optional shim kit #FC5393. Contact your authorized Rotary repair service.</p>		

TROUBLESHOOTING FOR AUTHORIZED MAINTENANCE PERSONNEL

The  switch is pressed, but the lift is not raised.

Problem	Cause	Countermeasure
 switch is pressed, but nothing happens.	1. Operation is not functioning.	1. Replace the operation element.
Motor does not run (both columns).	1. Wrong power supply to the power supply unit.	1. Correct power supply to the motor.

Down switch  is pressed, but the lift is not lowered.

Problem	Cause	Countermeasure
 switch is pressed, but nothing happens.	1. Operation is not functioning.	1. Replace the operation element.
The pawls do not latch.	1. Pawl spring (latch spring) defective.	1. Replace the pawl spring (latch spring).

Down switch  is pressed, but the lift is not lowered.

Problem	Cause	Countermeasure
 switch is pressed, but nothing happens.	1. Operation is not functioning.	1. Replace the operation element.

M-VERSION: Operation lever is pressed, but the lift is not lowered.

Problem	Cause	Countermeasure
Operation lever is pressed, but nothing happens. Operating lever for unlocking and activated button or lowering pressed down, but nothing happens.	1. Operation wire rope torn. 2. Press button or lowering valve defect.	1. Replace the wire rope. 2. Replace the micro-switch.

ADJUSTMENT OF THE SYNCHRONIZATION WIRE ROPES

Press  and raise the lift to check the tension of the synchronization wire ropes. Hold neighboring wire ropes under the carriage between thumb and index finger and pull the wire ropes together with approximately 67 N (Fig. 4). Adjust at the upper fastenings (Fig. 5).

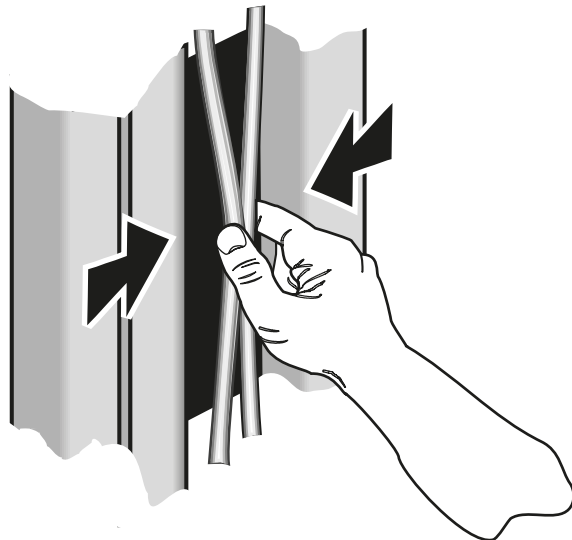

Fig. 4

Fig. 6 Detail	
A	Upper wire rope fastening plate and 1/2" nylon insert safety nut.
B	Lower wire rope fastening plate and 1/2" nylon insert safety nut.

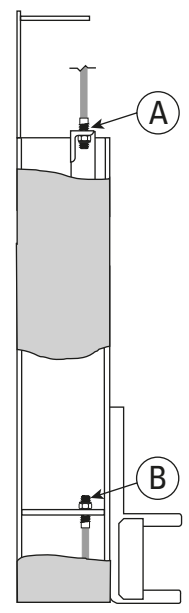

Fig. 5

MANUAL LOWERING OF THE LIFT

When the lift has been raised and power fails, it is important to know how to lower the lift manually. Make sure that the work area is free of interfering objects and that no unauthorized persons are in the area.

- 1.) Set a hydraulic car jack under the carriage on the side of the main operation panel. The car jack should have a load capacity corresponding to the vehicle weight.
- 2.) Raise the lift from the pawl (latch). The lift has to be raised only approximately 2 mm for unlatching.
- 3.) Remove the covers of the main operation panel and the auxiliary unit. Press the pawl (latch) where it is connected with the magnet (A, Fig. 6). If it cannot be pushed down with a finger, the pawl (latch) still is latched. Repeat step 2 until the pawl no longer is latched.
- 4.) Tie the pawl (latch) with wire, so that it will not latch again.
- 5.) Slowly lower the car jack under the arm guide.
- 6.) Repeat steps 1 to 5 with the column of the auxiliary unit.
- 7.) Now the lift is held by the hydraulics.
- 8.) Remove the cover of the lowering valve and turn and pull to lower the lift (B, Fig. 6). The lift lowers slowly.

IMPORTANT

Remove the wire (from step 4) from the pawls. Replace the cover of the lowering valve when the lift has been lowered.

- 9.) In case of a general power failure, the lift will function again when the power supply recovers.
- 10.) If there was no general power failure, a trained electrician must check the wiring, or you must contact authorized service personnel.

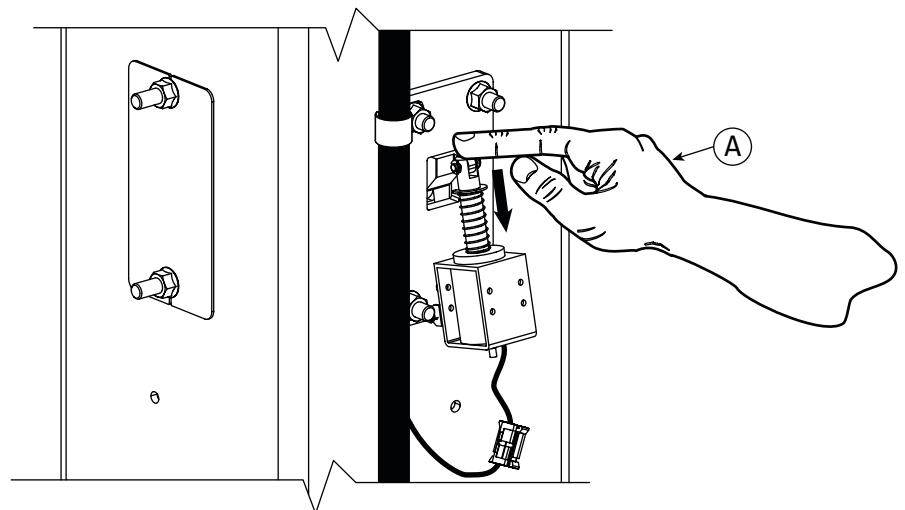
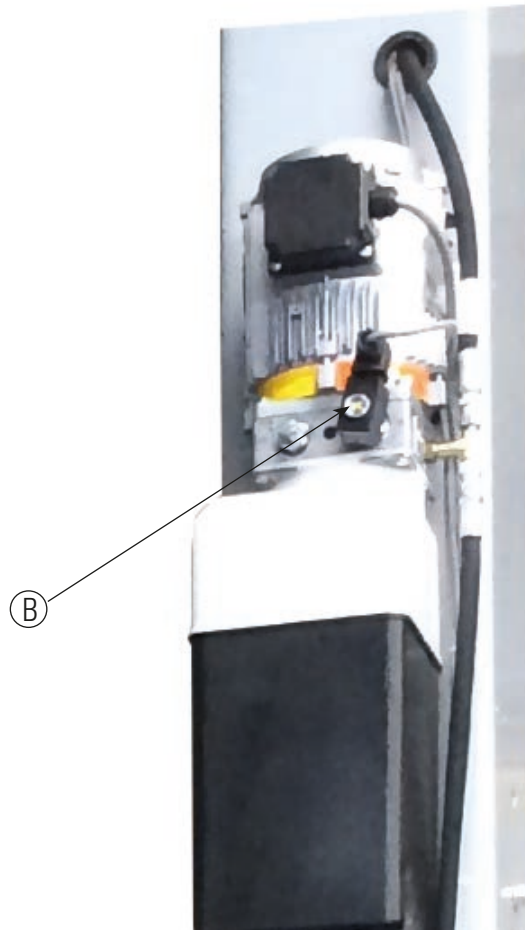

IMPORTANT

This applies only for the E-version. For the M-version, operation is performed manually with the operation lever.

Fig. 6

This page intentionally blank.

Trained operation personnel and periodic maintenance insure a satisfactory operation behavior of your Rotary lift.

Spare Parts: Refer to the list of spare parts in the documentation for the installer. Order original Rotary spare parts from your nearest authorized spare parts dealer.

Maintenance Support: Contact your local Rotary dealer. If you need further support, contact Rotary Lift at one of the following telephone numbers.

**European
Headquarters
BlitzRotary GmbH**
Hüfingerring Straße 55
D-78199 Bräunlingen
Telephone: +49.771.9233.0
Fax: +49.771.9233.99
info@blitzrotary.com
www.blitzrotary.com

A  **DOVER** COMPANY

Worldwide Contact Information
World Headquarters/USA: 1.812.273.1622
Canada: 1.905.812.9920
United Kingdom: +44.178.747.7711
Australasia: +60.3.5192.5910
Latin America/Caribbean: 1.812.273.1622
Middle East/Northern Africa: +49.771.9233.0
Southern Africa: 1.812.273.1622
Brazil: +55.11.4534.1995

