

YUCON



Rev.



SUMMARY

1	REVISION OF THE MANUAL	5
2	INTRODUCTION	6
3	LEGEND OF THE SYMBOLS USED	7
4	SAFETY RULES	9
4.1	Intended Use	9
4.2	Glossary	9
4.3	General Rules	10
4.4	Operator Safety	11
4.5	Device Safety	12
4.6	Safety Devices	14
4.7	Safety Precautions to follow when using the Refrigerants	14
4.8	Workplace Safety	14
4.9	Guidelines for the Handling of the Refrigerants Used	15
4.9.1	Refrigerant Storing Precautions	15
4.9.2	Refrigerant and System Conditions	15
4.9.3	Recycling Capacity	15
4.9.4	In General	15
5	NORMATIVE INFORMATION	17
6	OPERATION OF THE RADIO DEVICES	18
7	YUCON	19
8	DESCRIPTION	21
8.1	Containers	23
9	INSTALLATION	24
9.1	Unwrapping the Device	25
9.2	GAS KIT installation	26
10	POWER SUPPLY	27
11	POWER ON/OFF	28
11.1	Stopping the Equipment for Long Periods	28
12	SETTING UP BEFORE USING	29
12.1	How to Fill the Bottles	29
12.2	How to Fill the Internal Tank	29
12.3	How to Load the Paper into the Printer	30

12.4	Initial Configuration	30
12.4.1	Demo Mode	31
13	COMMUNICATION	32
13.1	Wi-Fi	32
13.2	Bluetooth	33
13.3	USB	33
14	NOTIFICATIONS	34
14.1	Visual Warnings	34
14.2	Audio Warnings	34
15	User Instructions	35
16	UPDATING	36
17	MAINTENANCE	37
17.1	Replacing the Filter Dryer and Mechanical Filter	39
17.2	How to Replace the Vacuum Pump Oil	42
17.3	Replacing the Paper in the Printer	43
17.4	Periodical Checks	43
17.5	Periodical Safety Checks	44
18	TECHNICAL FEATURES	45
19	HYDRAULIC DIAGRAM	48
20	CONTACTS	49

YUCON TECHNICAL MANUAL

1 REVISION OF THE MANUAL

This document is the technical manual for the product: YUCON

Document Review Number: 01

Date of Issue: 01/03/2024

INFORMATION



Read this manual before using the product.

Read the documents carefully whenever the General Risk symbol is shown.

2 INTRODUCTION

Dear Customer,

thank you for choosing this product for your workshop.

We are certain that you will get the greatest satisfaction from it and receive a great deal of help in your work.

Please read through the instructions in this manual carefully and keep it for future reference.

Reading and understanding the following manual will help you avoid damaging things and injuring people due to an improper use of the product it refers to.

We reserve the right to make any changes deemed necessary to improve the manual for any technical or marketing requirement, at any time and without prior notice.

This product is intended to be used exclusively by technicians specialised in the Automotive industry. Reading and understanding the information in this manual cannot replace adequate specialised training in this field.

The sole purpose of the manual is to illustrate the functioning of the product sold. It is not intended to offer technical training of any kind and technicians will therefore carry out any interventions under their own responsibility and will be accountable for any damage or personal injury caused by negligence, carelessness, or inexperience, regardless of the fact that this tool has been used following the information contained in this manual.

Any additions to this manual, useful in describing the new versions of the program and the new functions associated to it, may be sent to you through the technical bulletin service.

This manual is to be considered an essential part of the product to which it refers to. If it is resold, the original buyer is therefore required to forward the manual to the new owner.





Reproduction, whole or in part, of this manual in any form without written authorisation by the manufacturer is strictly forbidden.



The original manual was written in Italian, every other language is a translation of the original manual.

© **copyright and database rights 2023. 2024.** The material contained in this publication is protected by copyright and database rights. All rights are reserved by law and under international conventions.

3 LEGEND OF THE SYMBOLS USED

Some of the symbols indicated below may not be used in the manual.

	Toxic material hazard		Laser beam hazard
	Explosive material hazard		Low temperature danger - freezing
	Electric shock hazard		General Risk
	Electromagnetic field hazard		Obligation to read the instructions
	Flammable material hazard		Safety glasses required
	Hot surface hazard		Protective gloves required
	Corrosive substance hazard		Protective clothing required
	Risk of noise level above 80 dB(A)		Respiratory protection required
	Moving Parts Risk		Disconnect mains plug from electrical outlet
	Risk of crushing hands		Do not wet the device
	Floor level obstacle warning		

	This is not a safety symbol. It indicates a hazardous situation which, if not avoided, will result in serious permanent injury or death.
	This is not a safety symbol. It indicates a hazardous situation which, if not avoided, may result in serious permanent injury or death.
	This is not a safety symbol. It indicates a hazardous situation which, if not avoided, may result in minor injury.

<i>NOTICE</i>	This is not a safety symbol. It indicates a hazardous situation which, if not avoided, may result in material damage.
INFORMATION	This is not a safety symbol. It indicates important information.

4 SAFETY RULES

The technology used for the design and production control of the **YUCON** charging stations make them simple, reliable and safe to use.

The personnel in charge of using the charging stations is required to follow the general safety rules, use the charging stations for their intended use only and keep them properly, as described in this manual.

All the safety requirements issued by the following must be assessed and applied:

- *Labour inspectorate.*
- *Trade associations.*
- *Vehicle manufacturers.*
- *Anti-pollution regulations.*

in force in the country where the product is used.

4.1 Intended Use

Product	Intended Use
YUCON	Charging and servicing A/C and climate control systems on: <ul style="list-style-type: none"> • <i>vehicles</i> • <i>truck</i> • <i>agricultural vehicles</i> The vehicle's A/C and climate control system must use one of the following refrigerants: <ul style="list-style-type: none"> • <i>R1234yf</i> • <i>R134a</i> • <i>R456a</i> • <i>R444a</i>

4.2 Glossary

- **Equipment:** *any YUCON charging station.*
- **Operator:** *qualified individual, in charge of servicing A/C systems using the equipment.*
- **Internal cylinder:** *refrigerant storage cylinder.*
- **A/C system:** *A/C or climate control system.*
- **Refrigerant:** *a liquid capable of vaporising.*
- **External cylinder:** *new refrigerant cylinder used to fill the internal cylinder.*
- **Cycle:** *the carrying out of single phases.*
- **Operating phase:** *the carrying out of a single operation by the equipment (i.e. recycling).*
- **Non-condensable gases:** *air accumulated during the vapour phase in the refrigerant, extracted from the A/C system or from the cylinders.*
- **UV tracer injection:** *introduction of UV tracer into an A/C system in order to check for leaks.*
- **Oil injection:** *introduction of oil into an A/C system in order to restore the correct quantity recommended by the manufacturer.*

- **Recovery:** removal of the refrigerant from an A/C system and the subsequent storage in the internal cylinder, without the need for analysis or treatment.
- **Recycling:** reduction of the contaminants in the refrigerant used by separating the oil, removing the non-condensable gases and passing the refrigerant once (or multiple times) through elements that reduce the humidity, acidity, etc.
- **Filling:** phase for charging the refrigerant into an A/C system with the quantity recommended by the manufacturer.
- **Vacuum:** the evacuation of non-condensable gases and humidity from an A/C system exclusively through a vacuum pump.
- **Disposal of the equipment:** removal of the refrigerant destined to be stored in order to be destroyed or transferred to waste disposal plants later.

INFORMATION

The definition of "operator" cannot be applied to minors or to people with reduced physical, sensory or mental capabilities or without any experience or knowledge required.

4.3 General Rules



The operator must carefully read and understand all the information and instructions in the technical documents provided with the equipment. If the operator cannot read this manual, it is responsibility of the owner of the equipment/employer/person in charge of the safety to illustrate the contents of this document and adequately train the operator in relation to the operating instructions and safety measures for a proper use of the equipment.

- The operator must have basic knowledge of refrigeration, the refrigeration system, refrigerants and the potential hazards that equipment under extreme pressure can cause.
- The operator that works on vehicles must have basic qualifications and knowledge of mechanics, automotive engineering, vehicle repairing and of the potential dangers that may arise during self-diagnosis operations.
- The operator must be completely clear-headed and sober and not take drugs nor drink alcohol before or when using the equipment.
- The operator must follow all the instructions provided in the technical documents.
- The operator is required to wear adequate personal protective equipment (PPE) at all times when using the equipment.
- The operator must monitor the equipment during the operating phases wherever this is possible in compliance with the safety measures indicated below.
- The operator must periodically check the electrical connections of the equipment, making sure they are in good condition and immediately replacing any damaged cables.
- The operator must periodically check the parts that are subject to wear and replace them if necessary, using only original spare parts or spare parts approved by the manufacturer.
- The operator must stop using the equipment immediately should any failure occur, and promptly contact the technical assistance.
- Contact your retailer for extraordinary maintenance operations.
- Do not remove or damage the labels/tags and the warnings on the equipment; do not in any case make them illegible.

- Do not remove or tamper with any safety devices the equipment is provided with.

4.4 Operator Safety

WARNING

Refrigerant fluids can cause blindness and other physical injuries.



Due to their low boiling temperature (approximately - 30 °C), refrigerants can cause cold burns when they come into contact with the skin.

Safety Measures:

- The operator must avoid inhaling the vapours of the refrigerant liquids; use appropriate protection when required.
- The operator is required to wear adequate safety glasses and gloves that prevent direct contact with the refrigerants.
- Do not use the equipment near open flames, sparks, hot surfaces: the refrigerant decomposes at high temperatures, letting off toxic chemical substances that are harmful to people and the environment.

CAUTION

The equipment has been designed to be steady both when being moved and once it is positioned.



However, you must pay attention while moving it.

Safety Measures:

- Do not tilt the equipment in any way.
- Do not step on the equipment.
- Do not hang loads that may compromise the stability of the equipment, causing it to tip over.
- To move the equipment, use the specific handle only and balance the station on its wheels.
- Avoid moving it on uneven surfaces.

CAUTION

The equipment was designed to be electrically safe and to work with specific supply voltage levels.



Improper use may expose the operator to the risk of electric shock, even though of low intensity.

Safety Measures:

- Wear adequate personal protective equipment during all the operating phases.
- Do not handle or touch the equipment or any accessories (e.g. cables) with wet hands.
- Do not use extension cords to power the equipment.

! WARNING

The current used during the operating phases generates electromagnetic fields (EMF) near the equipment.

Even though of low intensity, these fields may interfere with medical prostheses, such as pacemakers.

Safety Measures:

- *Keep away from the equipment after launching the operating phases.*
- *If you have a medical prosthesis (e.g.: pacemaker), check with your doctor as to the appropriateness of using the equipment or being near it.*

4.5 Device Safety**NOTICE**

The equipment was designed in accordance with the regulations about pressure equipment and assemblies, evaluating and reducing the risk where present and making appropriate considerations.

However, vibrations, pressure variations or excessive temperatures, especially if cyclic, should be avoided.

Safety Measures:

- *During use, do not move out of the TS operating temperature range and do not exceed the PS maximum operating pressure (see plate on the equipment).*
- *Only use suitable refrigerants for the specific fittings on the installed GAS KIT.*
- *Make sure you use the correct refrigerant for the model of the device you are using.*
- *Make sure you use the correct refrigerant for the vehicle you are working on.*
- *Connect the hoses correctly by following the colours indicated: Blue hose - LP coupler, Red hose - HP coupler.*
- *Connect both hoses to the corresponding connections of the same group (both hoses connected to GAS1 group or both hoses to the GAS2 group).*
- *Make sure all the valves are closed before connecting the device to the A/C system or to an external cylinder.*
- *Make sure the operating phase has come to an end and the valves are closed before disconnecting the device; this should be done to avoid the refrigerant from spreading into the atmosphere.*
- *It is absolutely forbidden to modify the calibration of the safety valves and the control systems.*
- *Do not smoke near the device or during the operating phases.*
- *Do not expose the device to direct sunlight, rain and bad weather conditions.*
- *Disconnect the hoses with extreme caution; they may contain refrigerant under high pressure.*
- *Make sure the couplers are not open when the hoses are placed back around the service hose holder.*
- *Do not leave the device connected to the power supply if you do not intend to use it immediately.*

NOTICE

The equipment was designed to be used in specific environmental conditions.

Using the equipment in environments with temperatures and humidity that differ from those specified may impair its efficiency.

Safety measures:

- *Place the equipment in a dry area.*
- *Do not expose or use the equipment near heat sources.*
- *Place the equipment where it can be properly ventilated.*
- *Do not use corrosive chemicals, solvents or harsh detergents to clean the equipment.*
- *If storing the device for a long period of time, disconnect it from the power mains and put it in a safe place, where it is not exposed to outside weather conditions.*

NOTICE

The equipment was designed to be mechanically sturdy and suitable for use in the workshop.

Careless use and excessive mechanical strain may impair its efficiency.

Safety measures:

- *Do not drop, shake or bump the equipment.*
- *Do not place the equipment where it could fall into water. Avoid any contact with water.*
- *Do not place any objects on the cables or service hoses.*
- *Do not perform any kind of intervention that may damage the equipment.*
- *Do not use the touchscreen with sharp objects or any other kind of objects that may damage it.*
- *Do not access the components inside the equipment unless explicitly requested by specific maintenance operations indicated in this manual.*

NOTICE

The equipment was designed to be electrically safe and to work with specific supply voltage levels.

Failure to comply with the specifications related to the power supply may impair its efficiency.

Safety measures:

- *Do not expose the equipment to water or other liquids.*
- *Do not use external batteries to power the equipment.*
- *Do not use extension cords to power the equipment.*

! WARNING

The electromagnetic compatibility tests carried out on the tool guarantee that it can be adapted to the technologies normally used on vehicles (e.g.: engine check, ABS, airbag, etc.). Nevertheless, if malfunctions occur you should contact the vehicle's dealer.

4.6 Safety Devices

This equipment is provided with the following safety devices:

- **Safety pressure switch:** stops the compressor when the pressure reaches a cut-off level.
- **Safety valve:** opens completely in the event the PS value is reached.
- **Main switch:** allows you to cut off the power supply from the power mains in case of an emergency or in order to carry out maintenance.

Tampering with the above mentioned safety devices of any kind is strictly forbidden.

4.7 Safety Precautions to follow when using the Refrigerants

WARNING



Some mixtures of air and refrigerant have proved to be combustibile at high pressures.

These mixtures are potentially hazardous and can cause fires and explosions, causing personal injuries and damage to objects.

Further safety and medical information can be obtained from lubricant and refrigerant manufacturers.

Safety Measures:

- Do not use external tanks or other storage systems that have not been approved and/ or that are not equipped with safety valves.
- Do not test equipment or vehicle A/C systems containing R134a with compressed air.

WARNING



The R1234yf refrigerant is classified as flammable.

Safety Measures:

- Consult the safety sheet of this refrigerant in order to store it correctly.

4.8 Workplace Safety

NOTICE



The device is designed to work at a maximum altitude of 1000 m above sea level, with an operating temperature between 5 °C and 40 °C and a maximum humidity of 50% at 50 °C.

Safety Measures:

- This equipment should be used in locations with mechanical ventilation that provides at least four air changes per hour or the equipment should be used at least 0,5 m above the floor/ground.
- Keep the equipment in environments with temperatures that do not exceed 50 °C.

- *Only use the device in open or well-ventilated environments (at least 4 air changes per hour).*
- *Work in well-lit environments (the average operating illuminance value for mechanic workshops and assembly on work benches for precision work is 500-750-1000 lux).*

4.9 Guidelines for the Handling of the Refrigerants Used

4.9.1 Refrigerant Storing Precautions

The device has been designed and built to operate only with one of the following refrigerants:

- *R1234yf*
- *R134a*
- *R456a*
- *R444a*

Carefully follow the indications below:

- *The refrigerant removed from the A/C system must be handled with care, in order to prevent the refrigerants from mixing or in any case reduce the risk of this happening.*
- *The cylinders used for refrigerant storing must be specific to each refrigerant in order to prevent the refrigerants from mixing.*
- *The cylinders must be perfectly clean and clearly labelled in order to identify the refrigerant contained within.*

4.9.2 Refrigerant and System Conditions

The installment procedures and the maintenance carried out during the operating life of the A/C system substantially affect the quality of the refrigerant.

The understanding of these factors is essential in order to decide whether or not the refrigerant from a system should be recycled.

The systems that have not been properly maintained (not cleaned, not emptied correctly, etc.) can have high contamination levels, both in the refrigerant and in the oil.

If the history of the system is not known, the refrigerant recovered must at least be recycled before it is reused.

When the contamination level is not known, you may carry out some preliminary checks with the kit specifically for acidity and humidity measurements.

4.9.3 Recycling Capacity

The filtering systems of the device must be replaced regularly in order to guarantee device efficiency.

The recycling must always be carried out, even when tests do not show that they are required.

4.9.4 In General

Before carrying out the refrigerant refilling phase, the A/C system must be emptied and cleaned (a vacuum operation must be carried out).

Carry out all the procedures as described in this manual in order to guarantee that the A/C system is free of contamination.

Carry out the scheduled/regular maintenance on the device as required, especially after it has been used with a highly contaminated refrigerant: it is essential that the contamination from one operation is not passed on to the following one.

5 NORMATIVE INFORMATION

Declaration of Conformity

	<p>The manufacturer hereby declares that this YUCON charging station complies with the essential requirements and with all further provisions defined by directives:</p> <ul style="list-style-type: none">• <i>PED 2014/68/EU</i>• <i>EMC 2014/30/EU</i>• <i>LVD 2014/35/EU</i>• <i>MD 2006/42/EC</i>• <i>RED 2014/53/UE</i>• <i>RoHS 2011/65/EU and delegated Directive 2015/863/EU</i>
---	---

The Declaration of Conformity is available in paper format along with the other documents provided with the equipment.

6 OPERATION OF THE RADIO DEVICES

Wireless connection with Bluetooth and WiFi technology

Wireless connection with Wi-Fi and Bluetooth technologies supplies a standard and safe method for exchanging information between different devices using radio waves.

Besides our devices, this type of technology is also used by products such as: mobile phones, computers, printers, cameras, Pocket PCs, etc.

The Wi-Fi and Bluetooth interfaces search for compatible electronic devices based on the radio signal they generate and connect them.

Our devices make a selection and show only the compatible devices.

This does not exclude the presence of other sources of communication or interference.

THE EFFICIENCY AND THE QUALITY OF THE BLUETOOTH AND Wi-Fi COMMUNICATIONS MAY BE INFLUENCED BY THE PRESENCE OF RADIO DISTURBANCE SOURCES.

THE COMMUNICATION PROTOCOL HAS BEEN DEVELOPED TO MANAGE THESE TYPES OF ERRORS; HOWEVER, IN THESE CASES COMMUNICATION MAY BECOME DIFFICULT AND CONNECTION MAY REQUIRE SEVERAL ATTEMPTS.

SHOULD THE WIRELESS CONNECTION ENCOUNTER SERIOUS PROBLEMS THAT MAY COMPROMISE A REGULAR COMMUNICATION, THE SOURCE OF THE ENVIRONMENTAL ELECTROMAGNETIC INTERFERENCE MUST BE IDENTIFIED AND ITS INTENSITY REDUCED.

Position the tool so that the radio devices it is equipped with can work properly.

In particular, do not cover it with any shielding or metallic materials in general.

7 YUCON

The YUCON charging stations are designed for servicing A/C and climate control systems on cars, trucks and tractors.



The YUCON stations are high-performance and capable of carrying out the following operations in complete safety: recovery, recycling, vacuum, oil injection, UV tracer injection, system refilling and A/C system performance check.

YUCON is equipped with:

- *7" TFT touchscreen display*
- *DATABASE and performed services management*
- *10 kg tank*
- *Single stage vacuum pump*
- *High efficiency refrigerant recovery (over 95%)*
- *High-precision automatic oil drain management*
- *Automatic oil injection (timed operation)*
- *Band heater*
- *Operating modes:*
 - *DATABASE*
 - *CUSTOMISED SERVICE*
 - *MY DATABASE*
- *Multilingual software coverage*
- *Service hoses automatic length offset*
- *Automatic maintenance warning*
- *Simplified maintenance*
- *Incondensable gases automatic drain management*

YUCON can be purchased in the version that works with the refrigerant:

- *R1234yf*
- *R134a*

A kit containing specific fittings (GAS KIT) for the version purchased is provided with the equipment.

INFORMATION

The stations purchased in the version that works with the R134a refrigerant can be modified at any time, so that it can work with the R1234yf refrigerant.

The modification requires the installation of a specific RETROFIT KIT (optional).

8 DESCRIPTION

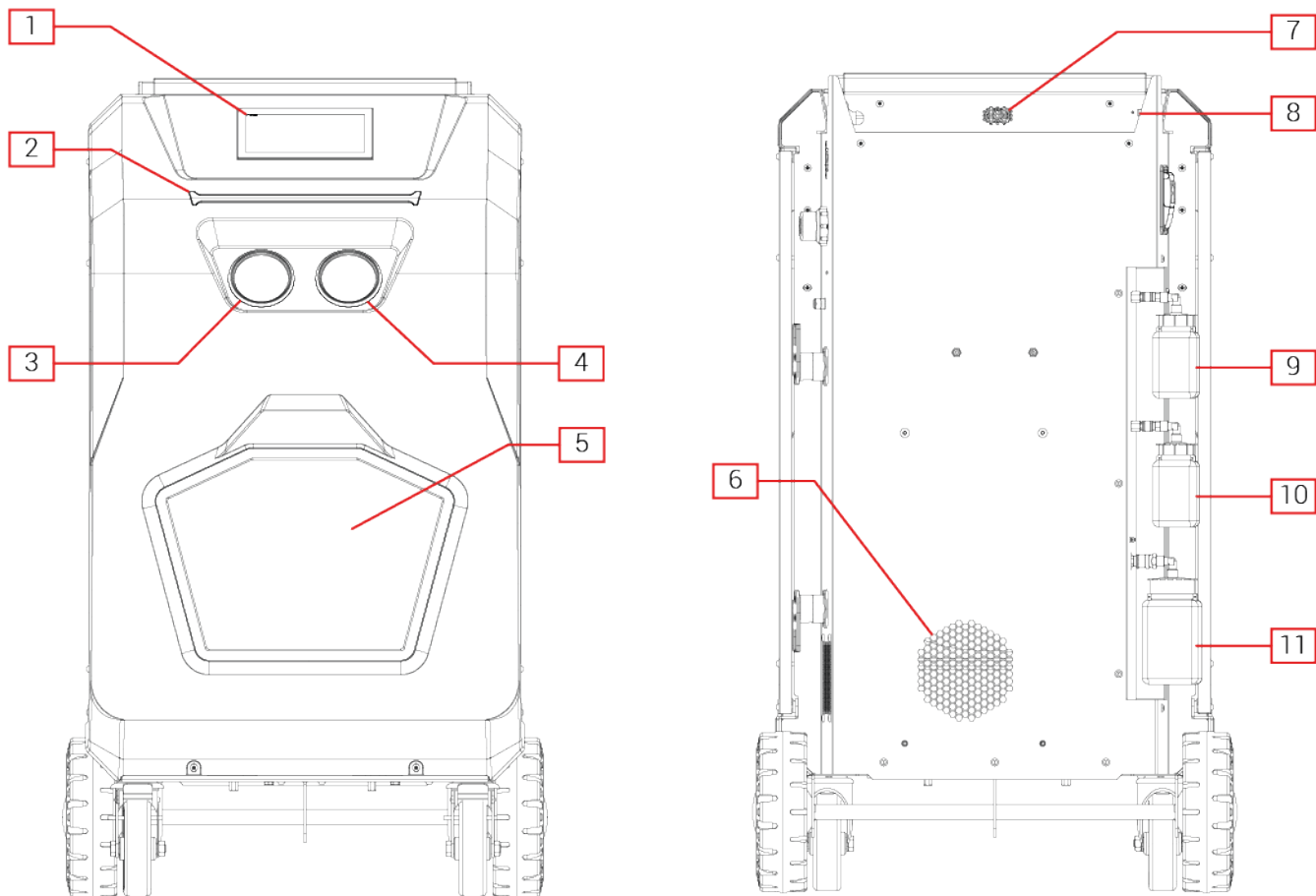

- 1. Controller
Touchscreen
Bluetooth and Wi-Fi communication modules
- 2. LED strip
- 3. High Pressure gauge (**HP**)
- 4. Low Pressure gauge (**LP**)
- 5. Air intake

- 6. Air intake
- 7. Speaker
- 8. USB connector
- 9. **OIL**:standard bottle for specific oil
- 10. **UV**:standard bottle for UV tracer
- 11. **DRAIN**:standard bottle to contain the recovered oil

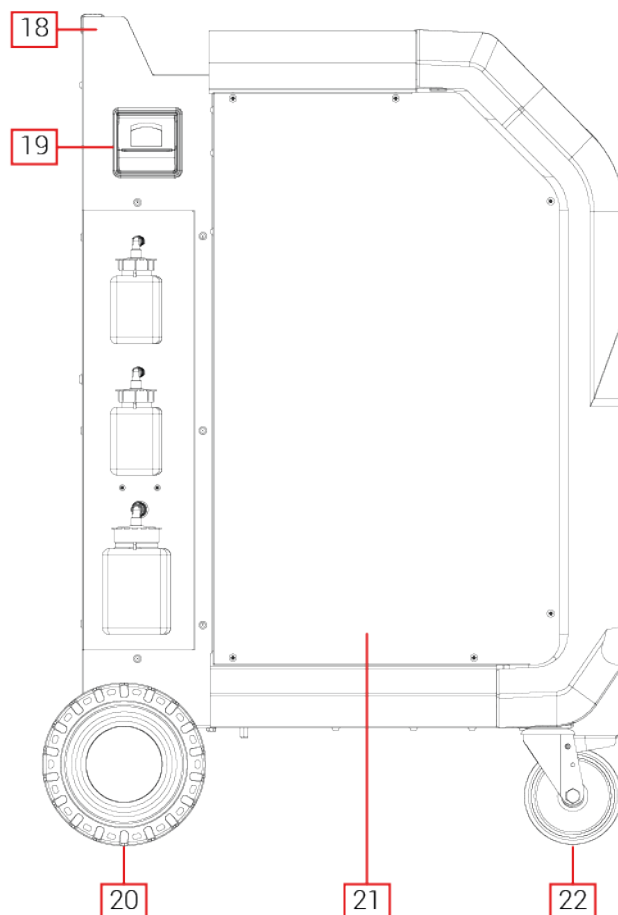
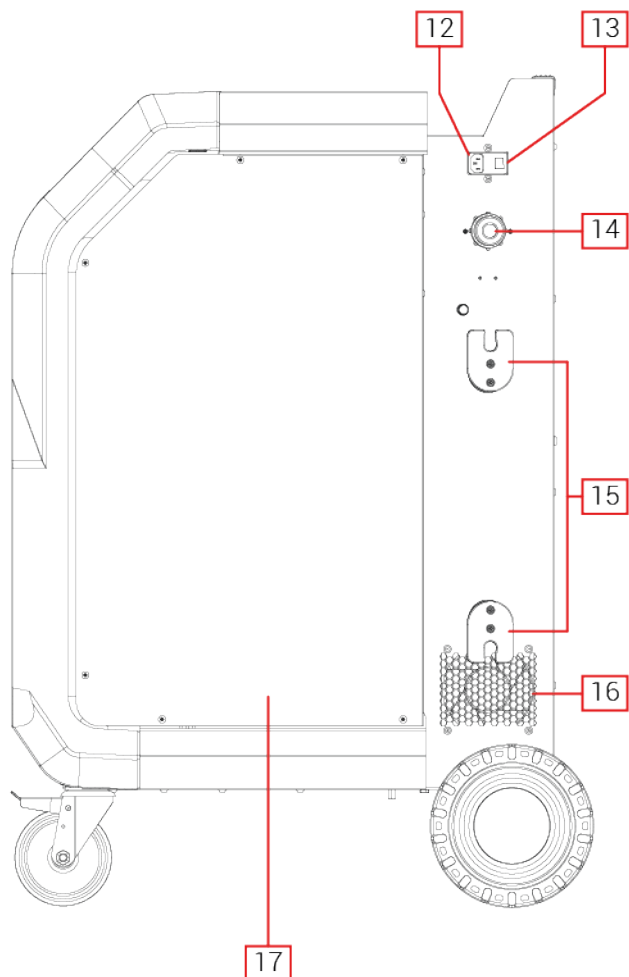

12. Power supply cable connector

13. Main switch

14. Setup for the **Refrigerant Identifier**¹

15. Power supply cable holder

16. Air intake

17. Right side panel

18. Handle

19. Printer¹

20. Oversized wheels

21. Left side panel

22. Castors with brakes

⁽¹⁾Optional

8.1 Containers

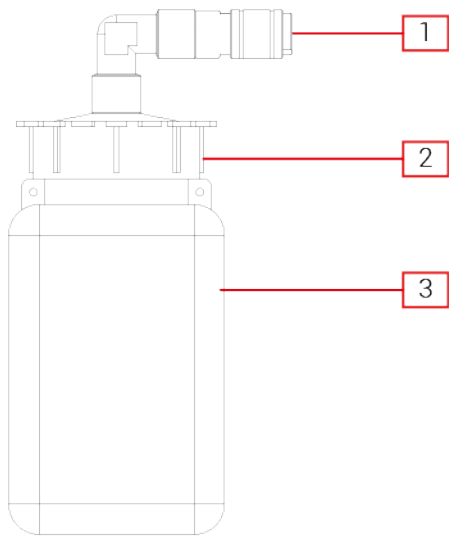

1. *Pneumatic connection*

2. *Tank cap*

3. *Tank*

The standard bottles can be identified by their different capacity:

- **OIL:** *PAG or POE oil, 250 ml*
- **UV:** *UV dye, 250 ml*
- **DRAIN:** *recovered oil, 500 ml*

9 INSTALLATION

This chapter describes the procedures required in order to install the device properly.

NOTICE

The installation must be performed by qualified personnel only, carefully following the instructions provided in this manual.



The device is provided with the following:

- **GAS KIT:**
 - *Fittings for the specific quick couplers for the refrigerant:**
 - *R1234yf*
 - *R134a*
 - *Stickers that identify the fittings*
- **POWER CABLE**
- **TANK FILLING KIT:**
 - *Recharging cylinder coupler*
 - *Paper gasket for recharging cylinder hose adapter*
 - *Copper gasket for HP recharging cylinder hose adapter*

()It is supplied with the pair of couplers related to the version of the equipment purchased.*

9.1 Unwrapping the Device

This chapter describes the instructions for unwrapping/unpacking the device.

NOTICE

Perform the described operations with extreme care and on a flat surface in order to avoid the device from tipping over.



Proceed as follows:

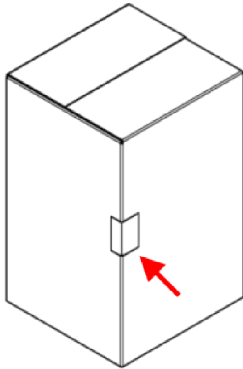

1. Remove the **GAS KIT**.
2. Remove the cardboard.
3. Remove the bands that fasten the equipment to the pallet.
4. Remove the equipment from the pallet.
5. Unlock the wheels.
6. Make sure the equipment is in good condition and that it has not been tampered with and/or damaged.
7. Make sure no parts are missing.

9.2 GAS KIT installation

This chapter describes the procedures that need to be carried out in order to install the GAS KIT.

When installing the kit remember that:

RED	always indicates High Pressure (HP) couplers
BLUE	always indicates Low Pressure (LP) couplers

NOTICE

Carry out the following operations with the equipment switched off and disconnected from the power mains.



Proceed as follows:

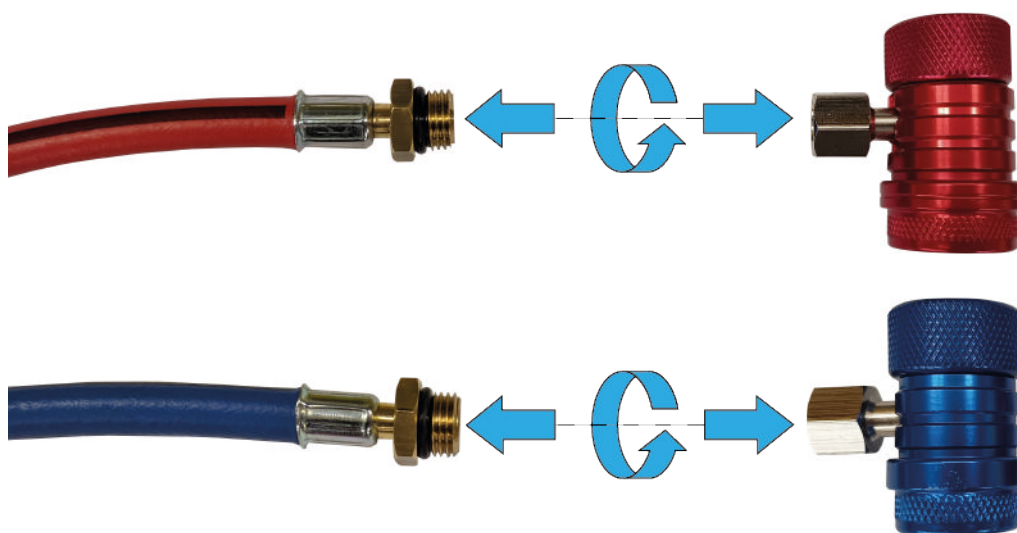

1. Locate the service hoses.
2. Make sure there are the specific O-rings at the base of the threaded connections.
3. Firmly tighten the quick couplers onto the threaded connections being sure to follow the colour indication:
 - *red coupler (HP) - red hose (HP)*
 - *blue coupler (LP) - blue hose (LP)*

10 POWER SUPPLY

The equipment is powered by the mains through a specific power supply cable.

The equipment must be connected to the mains through the supplied specific power cable; respect the applicable voltage, frequency and power values.

The voltage, frequency, and power values that can be applied can be found on the tag located near the main switch.



CAUTION

The mains plug must be used to disconnect from the mains.

Do not position the equipment so that it becomes difficult to disconnect it from the mains.

Do not use extension cords to power the equipment.

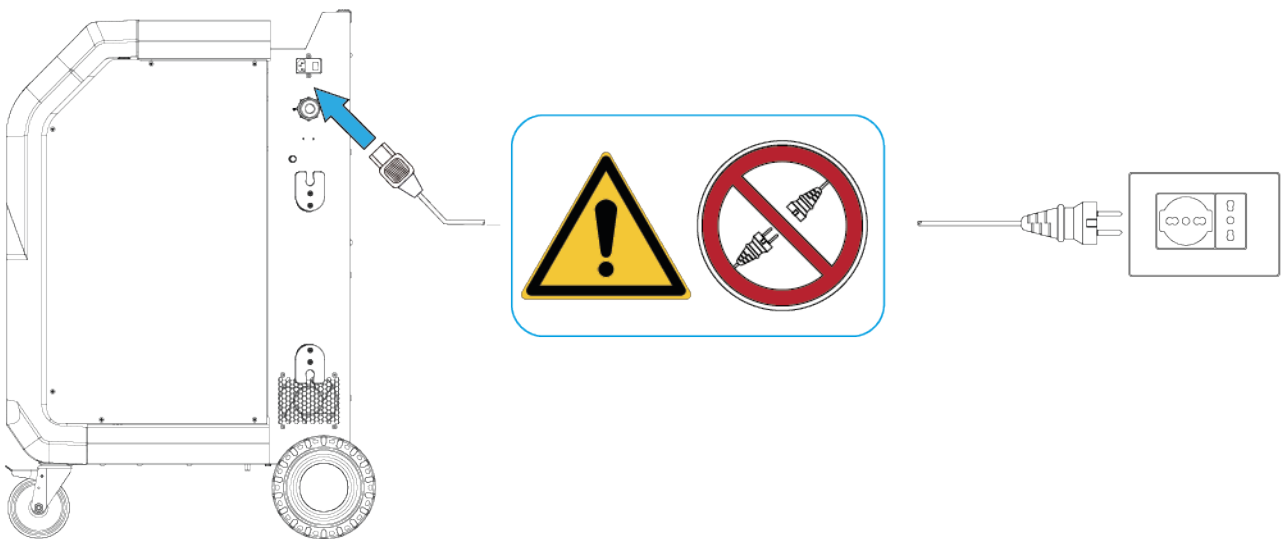

Proceed as follows:

1. *Stand on the correct side of the equipment.*
2. *Connect the power supply cable to the specific connector.*
3. *Connect the power supply cable to the mains via a grounded socket.*

11 POWER ON/OFF

The equipment can be powered on and off using the main switch located on the left side of the charging station.

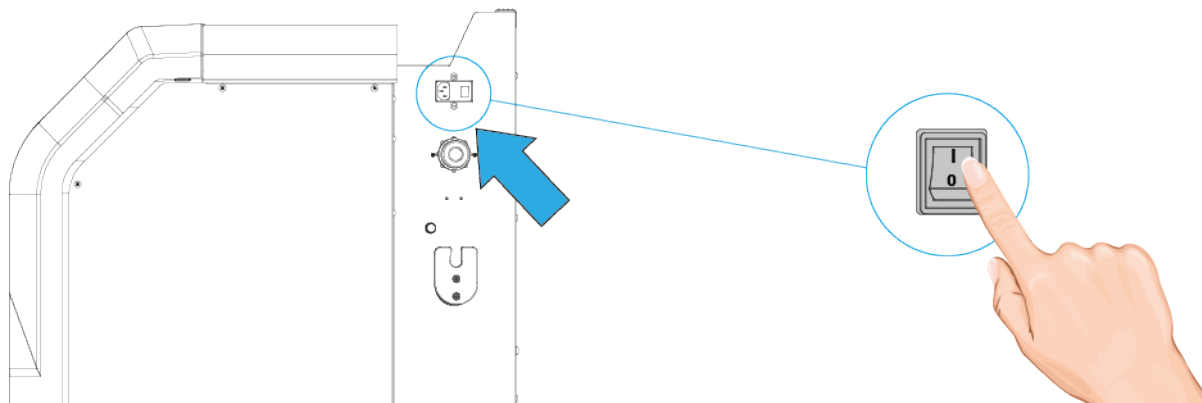

To turn on the equipment, set the main switch to the **I** (ON) position.

To turn off the equipment, set the main switch to the **O** (OFF) position.

WARNING

Do not disconnect the equipment from the mains by unplugging the power cable either from the equipment or from the socket.



11.1 Stopping the Equipment for Long Periods

Should you intend to stop the equipment for a long period of time, follow the instructions below.

Proceed as follows:

1. *Disconnect the equipment from the power mains.*
2. *Store the equipment in a safe place, not exposed to outside weather conditions.*

12 SETTING UP BEFORE USING

This chapter describes the maintenance operations required for setting up the equipment.

12.1 How to Fill the Bottles

The bottles provided with the device are empty upon delivery.
The **OIL** and **UV** bottles must be filled before use.

NOTICE

Fill the oil bottle with the correct type of oil (PAG/POE).



Proceed as follows:

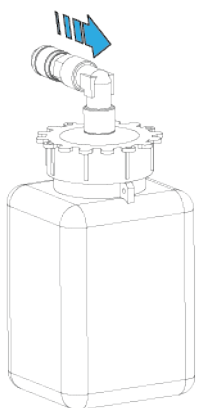

1. Remove the desired bottle by slightly pulling back the ferrule on the pneumatic coupler.
2. Unscrew the tank cap.
3. Fill the bottle with oil/UV tracer.
4. Screw the tank cap back on.
5. Reinsert the bottle by slightly pulling back the ferrule on the pneumatic coupler.

12.2 How to Fill the Internal Tank

Internal tank in the device is empty upon delivery.

NOTICE

You must carefully read and understand this Operating Manual in order to perform the provided instructions correctly.



Proceed as follows:

1. Turn on the equipment.
2. Launch the software function for the internal tank filling by selecting **ADDITIONAL FUNCTIONS** in the menu.
3. Follow the on-screen instructions.





For further information see the software's Operating Manual.

12.3 How to Load the Paper into the Printer

INFORMATION

The printer is an accessory that can be purchased separately and installed also on the other charging station models.

The buttons on the printer have the following functions:

Button	Name	Function
	PAPER FEED	It allows the paper to come out.
	ON/OFF	It allows setting the printer on on-line/off-line mode.

The printer is equipped with a green LED that indicates its status:

- **Solid on:** *printer on-line*
- **Flashing:** *the printer is off-line or there is no paper*
- **Off:** *printer off-line*

The printer is automatically on-line when the equipment is switched on.

Press  if the status LED indicates that the printer is off-line.

Using the printer, it is possible to print a report containing the following information:

- *company data*
- *vehicle data*
- *customer data*
- *operations carried out*



For further information see the software's Operating Manual.

You must fill the printer with paper before use.

Proceed as follows:

1. Lift the paper compartment opening lever lightly until the corresponding cover locks.
2. Place the paper roll into the specific compartment.
3. Close the compartment by pressing lightly on the cover and leaving a slip of paper sticking out.

4. Press  to make sure the paper has been inserted correctly.
5. Repeat the operations indicated above if the paper does not come out.

12.4 Initial Configuration

The first time the equipment is turned on, it requires you to select the software's display language.

Once selected, the configuration wizard is started.

This procedure allows you to:

- *configure the communication between the equipment and the workshop's Wi-Fi network;*
- *set the system date and time;*
- *enter the workshop data;*
- *select the type of refrigerant used;*
- *etc.*



For further information see the software's Operating Manual.

12.4.1 Demo Mode

The equipment includes a demo mode (**Demo**).

The equipment can be used in **Demo** mode for a **maximum of 15 power on-power off cycles**.

INFORMATION

The equipment locks automatically at the end of the cycle and can no longer be used.

To unlock the equipment, you must activate the product online. Alternatively, the equipment can be activated manually, requesting the unlock code to your retailer.

13 COMMUNICATION

The charging station's controller integrates the following:

- *Wi-Fi module*
- *Bluetooth module*

The charging stations also have a USB connector.

13.1 Wi-Fi

The Wi-Fi module built into the controller allows you to connect the charging station to the workshop's Wi-Fi network.

The Wi-Fi connection to the workshop's network allows the following:

- *connection to the printers in the network, to print reports in A4 format;*
- *download of updates;*
- *remote assistance;*
- *connection with the smartphone on which the app is installed.*

The connection to the Wi-Fi network must be configured through the software functions.

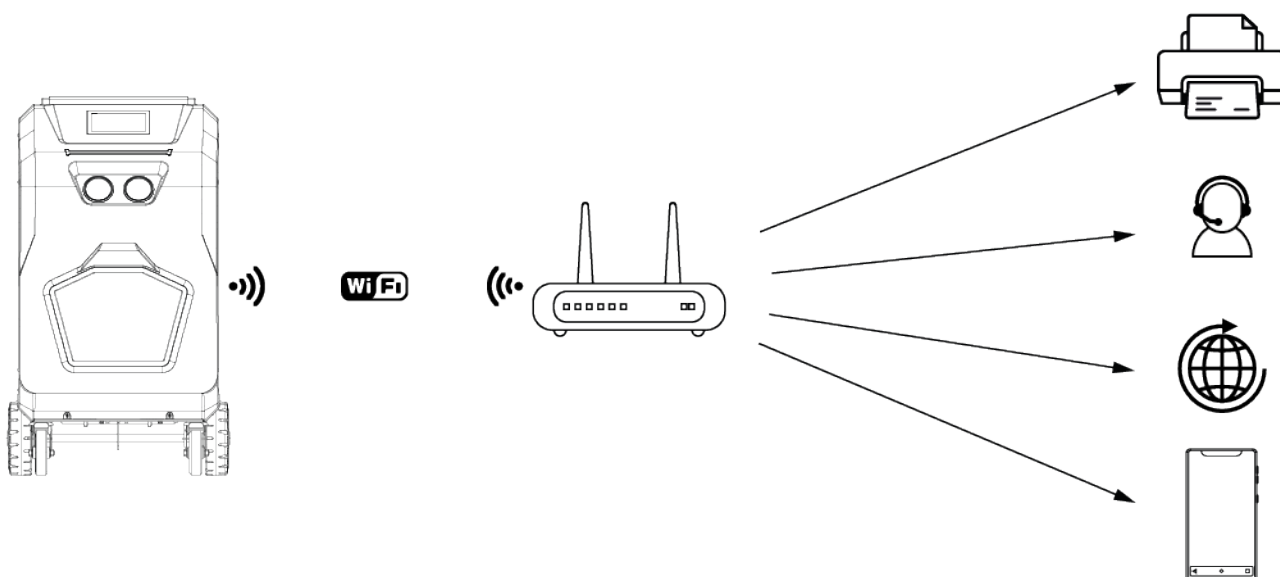

Proceed as follows:

1. *Turn on the charging station.*
2. *Access the communication configuration functions.*
3. *Start the configuration of the Wi-Fi communication.*
4. *Follow the on-screen instructions.*

INFORMATION

In order to print in A4 format, the charging station and the printer must be connected to the same Wi-Fi network.

To download updates and use the remote assistance functions, the Wi-Fi network must have an Internet connection.



For further information see the software's Operating Manual.

13.2 Bluetooth

The Bluetooth module built into the controller allows you to connect the charging station to accessories such as:

- *A/C system efficiency testing kit;*

The Bluetooth connection must be configured through the software functions.

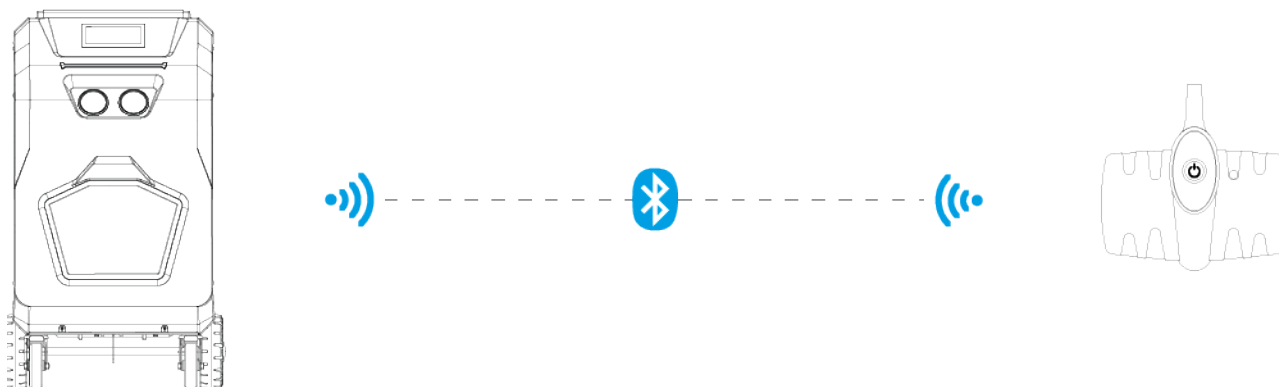

Proceed as follows:

1. *Turn on the charging station.*
2. *Access the communication configuration functions.*
3. *Start the configuration of the Bluetooth communication.*
4. *Follow the on-screen instructions.*



For further information see the software's Operating Manual.

13.3 USB

The USB connector located on the right side of the charging station allows you to:

- *back up the reports of the services carried out and the entire system;*
- *install updates in off-line mode if the workshop does not have a Wi-Fi network with an Internet connection.*







NOTICE

Do not connect devices to the charging station via the USB connector.

14 NOTIFICATIONS

14.1 Visual Warnings

The LED strip located on the front side of the charging station provides information on the status of the equipment:

COLOUR	PHASE	LED BEHAVIOUR	STATUS
	--	completely on	Awaiting commands
		repeated progressive activation	Operation in progress Ex.: Cylinder filling
	RECOVERY	repeated progressive activation	Phase in progress
		completely on	Phase completed
	VACUUM	repeated progressive activation	Phase in progress
		completely on	Phase completed
	INJECTION	repeated progressive activation	Phase in progress
		completely on	Phase completed
	CHARGE	repeated progressive activation	Phase in progress
		completely on	Phase completed
	--	alternated blinking	Error

14.2 Audio Warnings

The speaker located on rear side of the charging station emits an audible warning in the event of:

- *a completed charging service*
- *an interrupted charging service*

15 User Instructions

The software in the charging station allows selecting the vehicle to work on choosing among the ones in the database and launching all the functions required in order to charge and check the vehicle's A/C system.



CAUTION

Monitor the equipment at all times during the operating phases, making sure to wear adequate personal protective equipment.



Proceed as follows:

1. *Place the charging station near the vehicle you wish to work on.*
2. *Power the charging station and turn it on.*
3. *Select the type of service that must be carried out.*
4. *Follow the on-screen instructions.*

The software provides on-screen indications required in order to carry out the various operations and warns if errors occur during the phases.



For further information consult the software's Operating Manual.

16 UPDATING

The firmware and software can be updated via:

- *WiFi*
- *USB*

NOTICE

Keep the charging station on and powered as long as necessary for the update to complete.

The update via Wi-Fi requires connecting the charging station to the Internet through the workshop's Wi-Fi network.

If the workshop does not have a Wi-Fi network with access to the Internet, the update can be performed off-line using the **VSG AC MACHINE UPDATE** software.

This software allows you to download the software and/or firmware update pack from the Internet and copy it into a USB flash drive.

INFORMATION

We recommend using a USB flash drive with at least 8 GB of available space to download the update files.

Proceed as follows:

1. *Download the software from the website: <https://equipmentgroup.it/static/youcon/>*
2. *Install the software on a PC equipped with an Internet connection.*
3. *Connect the USB flash drive to the PC.*
4. *Launch the software.*
5. *Wait for the update to be downloaded onto the USB flash drive.*
6. *Disconnect the USB flash drive from the PC.*
7. *Turn on the charging station.*
8. *Connect the USB flash drive to the charging station.*
9. *Launch the software update function.*
10. *Wait for the update to complete.*



For further information see the software's Operating Manual.

17 MAINTENANCE

This chapter describes the maintenance operations required for the device.

CAUTION



Carefully follow the instructions provided in this manual. Only use original spare parts or approved by the manufacturer.

INFORMATION

For further help, contact your Retailer or the Technical Assistance service.

On the top of the service bulkhead there is a plate with all the information needed to contact the Technical Assistance Service.

Scheduled maintenance is made up of a series of operations that must be carried out periodically.

Specific messages will appear on your display each time a maintenance operation has expired and needs to be carried out.

Maintenance operation	Frequency
Dehydrator Filter Replacement	When prompted by the device.
Mechanical Filter Replacement	Along with the dehydrator filter replacement.
Vacuum pump oil replacement	When prompted by the device.
Printer Paper Replacement*	each time the paper runs out.

()Only for charging stations where the optional printer kit has been installed.*

WARNING



Unless indicated otherwise, the maintenance operations that require you to open the service door / bulkheads and to remove parts of the equipment must be carried out with the charging station switched off and disconnected from the mains.

When carrying out maintenance operations that require the equipment to be powered:

- operate on the indicated components only;
- avoid contact with live components (e.g. electrical wirings).

Below is the procedure for opening the side panels properly.

The procedure is the same for both panels.

Proceed as follows.

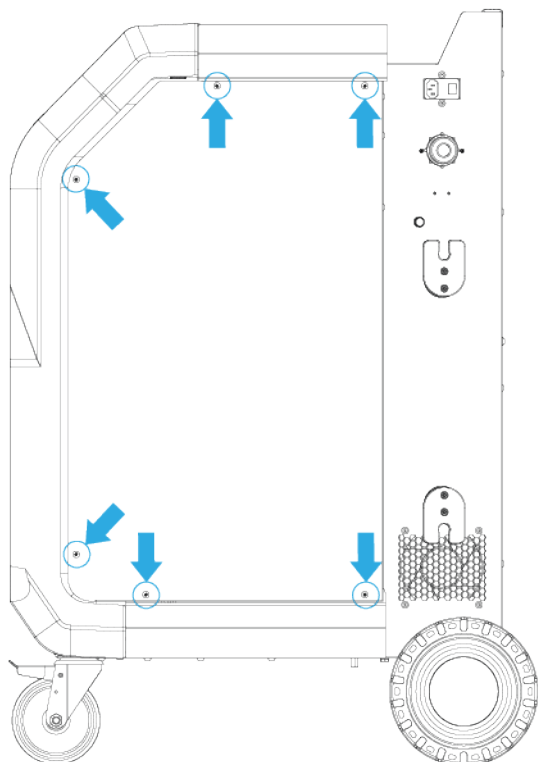

1. Stand on the side of the equipment.
2. Locate the panel that must be removed.
3. Loosen the screws that block the panel using a hexagonal wrench no. 3.
4. Remove the panel.

CAUTION



A ground cable is connected to the side panels.

The purpose of this connection is to guarantee electrical protection for the operator in case of current leakages and avoid shock hazards.

Pay the utmost attention to not disconnect the ground cable while removing the side panels.

In case of accidental disconnection:

1. Turn off the equipment.
2. Restore the connection.

17.1 Replacing the Filter Dryer and Mechanical Filter

The filter dryer must be replaced **when prompted to do so by the equipment**.
At the same time the mechanical filter must also be replaced.



- A) Mechanical filter
- B) Dryer filter

Given the position of the filters, proceed in the following order:

1. Remove the old filter dryer.
2. Remove the old mechanical filter.
3. Install the new mechanical filter.
4. Install the new filter dryer.

The procedure is detailed as follows.

CAUTION

There could be accidental refrigerant leaks while replacing the filters.



Carefully follow the instructions provided below in order to avoid the refrigerant from getting into the atmosphere.

Wear appropriate protective glasses and gloves when replacing the filters.



You must carefully read and understand this Operating Manual in order to perform the provided instructions correctly.

Proceed as follows:

1. Turn on the equipment.
2. Select: **ADDITIONAL FUNCTIONS > TOTAL AND RESETTABLE COUNTERS**
3. Locate the item: **A/C RECOVERY**
4. Press: **START FILTER REPLACEMENT**
5. Follow the instructions on the display.
6. Wait for the software to require removing the side panel.
7. Remove the right side panel.
8. Locate the **filter dryer**.

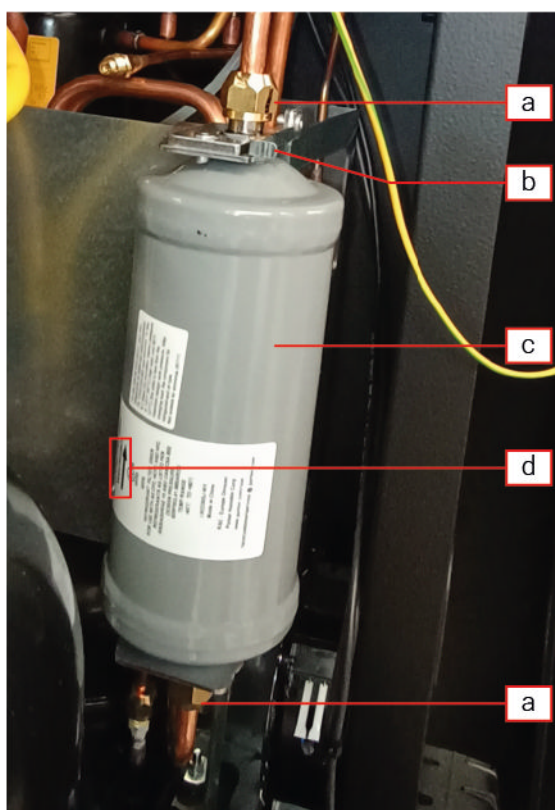

- a) Nut*
- b) Blocking clip*
- c) Filter*
- d) Arrow indicating the direction of the flow*

9. Open the blocking clip on the **dryer filter**.
10. Unscrew the 2 fixing nuts on the **filter dryer** using the specific hexagonal wrenches no. 16 and no. 19.
11. Remove the **dryer filter** extracting it from the other one.
12. Check that the sealing O-rings are in good condition and replace them if necessary.
13. Locate the **mechanical filter**.

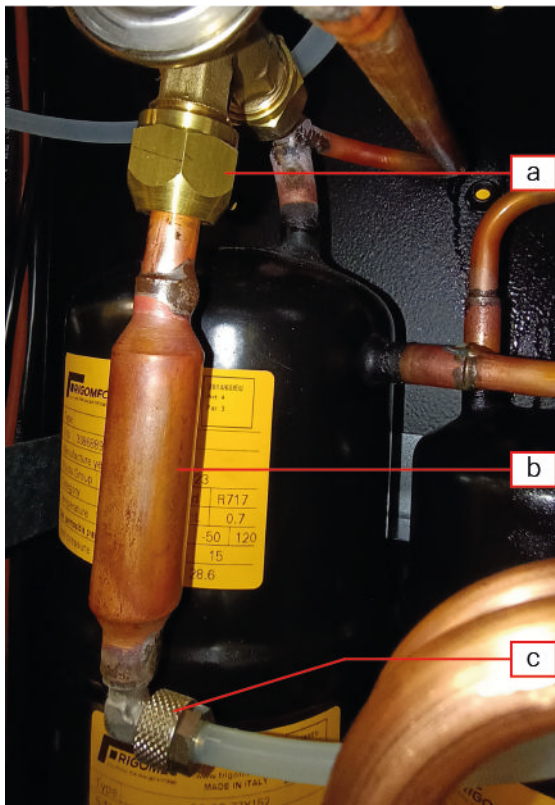

- a) *Constant expansion valve connection - mechanical filter*
- b) *Mechanical filter.*
- c) *Rilsan pipe connection - mechanical filter.*

14. Unscrew the Rilsan pipe connection - **mechanical filter**, using a fork wrench no. 10.
15. Unscrew the constant expansion valve connection - **mechanical filter**, using a fork wrench no. 19.
16. Remove the old **mechanical filter**.
17. Mount an O-ring on the new **mechanical filter** on the side of the constant expansion valve connection.
18. Remount the **mechanical filter** using the specific wrenches and tightening with a torque of approximately 17 N m.
19. Install the new **filter dryer** screwing the fixing nuts with a tightening torque of approximately 17 N m.

NOTICE

The arrow that indicates the flow in the filter must point upwards.



20. Close the blocking clip on the **filter dryer**.
21. Remount the side panel.
22. Complete the procedure following the instructions on the display.

17.2 How to Replace the Vacuum Pump Oil

The oil in the vacuum pump must be replaced **when you are prompted to do so by the device.**



You must carefully read and understand this Operating Manual in order to perform the provided instructions correctly.

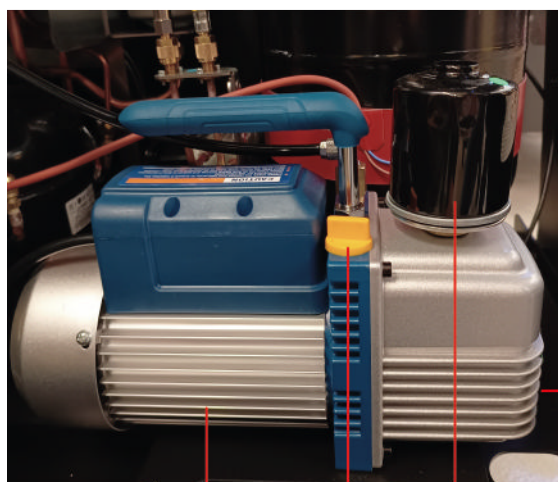

1. Vacuum pump
2. Filler cap
3. Oil filter
4. Pump oil level inspection
5. Oil drain cap

1

2

3

4

5

INFORMATION

On the bottom of the equipment there is a specific opening in front of which you can place a container suitable for collecting the waste oil.

The opening is near the oil drain cap.

Proceed as follows:

1. Disconnect the equipment from the mains.
2. Remove the left side panel.
3. Unscrew and remove the oil filler cap.
4. Loosen the oil drain cap using an hexagonal wrench no. 5.
5. Wait for all the oil to drain from the pump.

NOTICE

Collect the recovered oil and dispose of it according to the regulations in force.



6. Tighten the oil drain cap until it is well sealed.
7. Unscrew and remove the old oil filter.
8. Tighten the new oil filter until it is well sealed.
9. Insert new oil to the amount required.

INFORMATION

The correct level of the pump oil is at approximately half of the graduated scale on the pump oil level sight.

The total amount of oil to insert is approximately 370 ml.

10. Tighten the oil filler cap.
11. Make sure there are not any leaks from the side of the drain cap or from the filter.
12. Remount the side panel.
13. Connect the equipment from the mains.
14. Turn on the equipment.
15. Select: ADDITIONAL FUNCTIONS > TOTAL AND RESETTABLE COUNTERS
16. Locate the item: PUMP TIME
17. Press: RESET

17.3 Replacing the Paper in the Printer

Follow the instructions provided in the chapter **Replacing the Paper in the Printer**.

17.4 Periodical Checks

In order to guarantee a correct operation of the device we recommend you check the parts that are the most subject to wear on a regular basis.

Parts subject to wear	Check
Service hoses	Make sure there are no cuts, scratches or bulges.
Quick fittings	Make sure there are no signs of wear and that the hoses do not harden during use. Make sure the service hoses are connected properly. Make sure there are no cuts or scratches on the O-rings.
Oil and UV bottles	Make sure they are clear and not damaged.
Wheels	Make sure the brakes are working properly.
Power supply cable	Make sure there are no cuts, scratches or burns.

17.5 Periodical Safety Checks

In order to guarantee the correct operation of the device, carry out periodical checks on the safety devices.

The safety valve and safety pressure switch must be visually checked to verify that they are not damaged in order to guarantee that they are working properly.

WARNING



A periodic inspection of the operation of the safety devices (Safety Pressure Switch and Safety Valve) and of the integrity of the refrigerant liquid receiver must be carried out at intervals defined by the national regulations in force in the country in which the equipment is being used.

18 TECHNICAL FEATURES

Model	YUCON
Brand	RAVAGLIOLI
Builder	TEXA S.p.A.
Display	7" TFT IPS 1024x600 400CD
GPU	Qualcomm® Adreno™ 308 Graphics Processing Unit (GPU) with 64-bit addressing
Touch	Capacitive touch panel, USB/12C interface
CPU	<ul style="list-style-type: none"> • <i>SC200R Series Snapdragon QCM2150 Quad-core ARM Cortex-A53 64-bit CPU @ 1.3 Ghz</i> • <i>STM32F103 - ARM Cortex M3 32-bit CPU</i>
RAM	2 GB LPDDR3
Hard disk	16 GB eMMC
Operating system	Android 10.0
Audio peripheral devices	1 speaker CES-703116-28PM 8ohm 2W
Wi-Fi	802.11a/b/g/n, 150 Mbps, STA/AP/P2P 2402-2480 MHz
Bluetooth	2.1+EDR/3.0/4.1 LE/4.2 BLE 2400-2483,5 MHz
RF power	20 dBm
I/O peripheral devices	USB 2.0 x1
Primary battery	3 V CR2032
Secondary battery	NiMh 2,4 V - 600 mAh
Fluid / Group	R134a / 2 R444a / 2 R456a / 1 R1234yf / 1
Electronic refrigerant scale (Precision) [g]	± 10
Electronic oil and UV tracer scales (Resolution) [g]	1 (only oil drain)
Pressure transducer	KI. 1.0
High pressure gauge [mm]	Ø 80
Low pressure gauge [mm]	Ø 80
Tank capacity [kg]	10
Service pipes' length [m]	3
Filter assembly	1 combined filter + mechanical filter

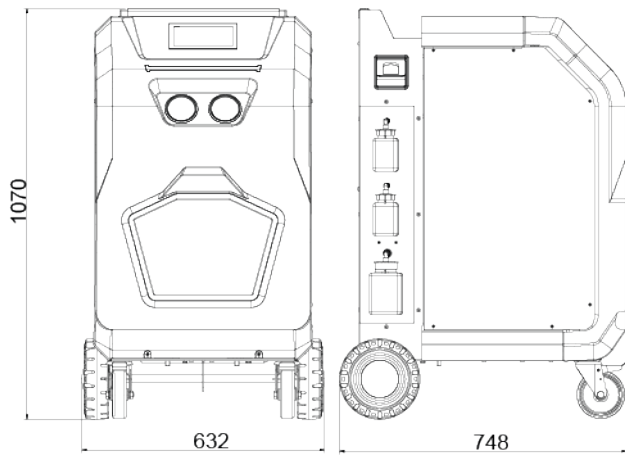

Compressor (airtight) [cc]	12
Vacuum pump	100 l/m, final pressure 0,2 mbar
Ambient temperature sensor (Resolution) [°C]	1
Refrigerant purity [kg]	150 (SAE J2099)
Recovery efficiency	> 95 %
Maximum operating pressure (PS) [bar]	24
Safety device calibration [bar]	25
Power supply voltage [V]	230
Frequency (Hz) :	50
Power [W]	770
Operation temperature (TS) [°C]	5 ÷ 40
Storing temperature [°C]	- 25 ÷ 60
Dimensions [mm]	 <p>The technical drawing shows two views of the vacuum chamber. The front view on the left indicates a height of 1070 mm and a front width of 632 mm. The side view on the right indicates a side width of 748 mm. The chamber has a hexagonal-shaped opening on the front and a control panel on the side with various gauges and valves.</p>
Weight [kg]	90

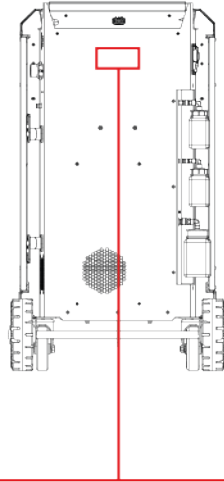
Data plate





Manufacturer: Via I Maggio,9
31050 Monastier di Treviso ITALY
MADE IN ITALY

SN: AD6AT00001

Anno/Year: 2024

Modello Type	YUCON	Brand	Ravaglioli	Manufacturer	TEXA S.p.A.
Alim. Volt-Frequenza Power Supply-Frequ.	230V - 50Hz			Fluido/Gruppo: Fluid/Group:	R134a / 2 R1234yf / 1 R456a / 2 R444a / 1
Potenza Assorb. Rated Power	770W				
Carica max fluido Max refriger. charge	10Kg	PS 25bar TS 5/40°C	Tar. Disp. Sicurezza Safety device calibr		28bar

Contiene gas fluorati ad effetto serra disciplinati dal Protocollo di Kyoto
Contains fluorinated greenhouse gases covered by the Kyoto Protocol

- **PS:** maximum operating pressure
- **TS:** operating temperature

19 HYDRAULIC DIAGRAM

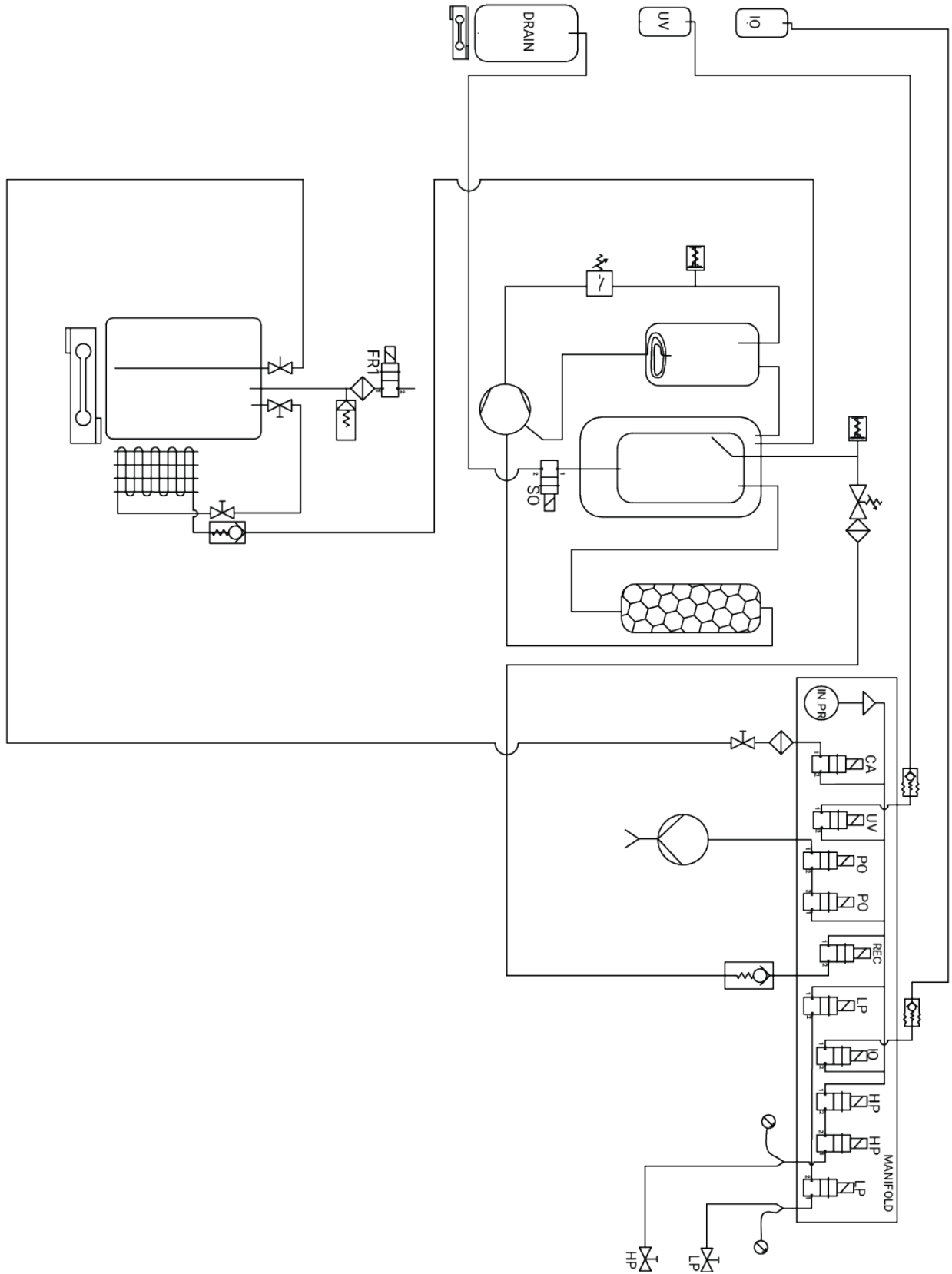

20 CONTACTS

Vehicle Service Group Italy S.r.l.

Via Filippo Brunelleschi 9

44020 Ostellato (FE), Italy

+39.051.6781511

© **VEHICLE SERVICE GROUP™**

All Rights Reserved. Unless otherwise indicated, RAVAGLIOLI, all the other trademarks are property of Dover Corporation and its affiliates.